

THE VSL3616, CPI'S 1.3 GHZ, 700 WATT CW, GAN SOLID STATE POWER AMPLIFIER

G. Solomon, D. Riffelmacher, R. Snyder, M. Tracy, T. Treado[#],
Communications & Power Industries, LLC, Beverly, MA 01915, USA

Abstract

The VSL3616 GaN SSPA is a 1.3 GHz, 700 watt CW, liquid-cooled solid state power amplifier (SSPA) see Fig. 1. It has exceptional amplitude and phase stability and is being used to drive the VKL9130A1 IOT in CPI's VIL410 30 kW CW IOT transmitter. The VSL3616 SSPA is configured in a 19 inch rack mount enclosure. Higher power levels can be obtained by power combining multiple VSL3616 SSPAs. The VSL3616 SSPA has been designed for very tight amplitude and phase control. The amplitude ripple and phase ripple are specified to be better than 0.05% RMS and better than 0.2° RMS, respectively. The stability of the output power is specified to be better than 0.1% over any 20 second period of time. This paper will describe the design and operation of the VSL3616 SSPA. Results from a 1000 hour life test will be presented.



Figure 1: VSL3616 Solid State Power Amplifier.

RF LINEUP

The SSPA consists of a two-stage driver amplifier assembly followed by two main amplifiers which are combined to provide output power. Using modular amplifiers allows various configurations to be accommodated for various applications without the need for redesign.

RF from two main amplifiers is combined using a CPI-designed Gysel power combiner that has low insertion loss and high port-to-port isolation. The combined output provides up to 750W of saturated RF power into a ferrite isolator that protects the SSPA from reflected power. The output of the isolator drives a dual directional coupler with a rear panel 7/16 DIN connector. The coupled outputs are used for forward and reverse power monitoring.

[#]todd.treado@cpil.com

ISBN 978-3-95450-132-8

2302

The VSL3616 meets the specifications listed in Table 1.

Table 1: Specifications and Measured Data

Parameter	Specification	Data
Frequency	1300 MHz	1300 MHz
3 dB Bandwidth	> 6 MHz	200 MHz
Gain	≥ 57 dB	59 dB
Output Power	≥ 700W CW	704 W CW
Input Power	≤ 1 mW	≤ 1 mW
Phase Variation over 16 dB Range	≤ ±15°	±12.5°
Gain Variation	<± 0.2 dB	± 0.07 dB
Amplitude Ripple	< 0.05% RMS	0.046% RMS
Phase Ripple	≤ 0.2° RMS	0.062° RMS
Power Stability over 20 second Interval	< 0.2%	0.026%
Efficiency	45 %	52%

IMPLEMENTATION

The RF transistors are all GaN devices. A mix of GaN on silicon transistors and GaN on SiC transistors are used. The input driver consists of two stages with an output power of 8W. The driver signal is split to drive 2 40W GaN on Si transistors which each drive a pair of 200W GaN on SiC transistors. Power is split and combined in the 200W stage in a 90 degree balanced configuration by quadrature hybrids. Low power hybrids are commercially available parts whereas high power combiners are designed by CPI. Figure 2 shows a simplified block diagram of the VSL3616 SSPA.

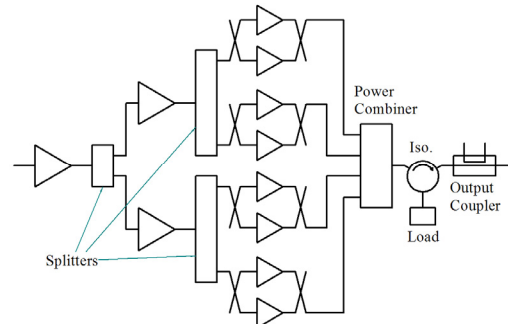

Figure 2: Simplified Block Diagram of VSL3616 SSPA.

Gate bias is generated and controlled by DC-DC switching converters which are well filtered for extremely low ripple which would otherwise result in undesired in-band spurious outputs. DC is applied to the drains of the active devices only when gate bias is applied and stable. Gate bias to all stages is temperature compensated to aid in overall stability.

In the IOT drive application, the amplifier generates approximately 700W of heat in the three modules. These modules and the DC power supplies are mounted on a water-cooled plate to minimize temperature rise during operation and to provide thermal stability. A stable water cooling temperature is required for the amplifier to meet the RF amplitude and phase stability requirements.

The system is contained in a 19 inch rack enclosure which is 4 units high and 26 inches deep. The modules are DC powered by two 30VDC line switching power supplies each capable of providing 30A. These are powered by 240 VAC and require approximately 1500 W of power at full RF output. On the first two SSPAs built and tested, the measured efficiency (ac wall-plug power to output RF power) was 51% and 52% at full power.

CONTROLS

Rear panel remote control is standard and offered via a rear panel D-sub “Network Interface” connector which accepts RS422 differential logic. Controls include enable for the DC power supplies and for the RF amplifier. The amplifier can be shut down in less than 10 microseconds should a fault be detected. Chassis temperature and other monitors such as detected RF forward and return power signals are available through the rear panel connector.

RF PERFORMANCE DATA

The VSL3616 SSPA was vigorously tested for use in accelerator applications. It is being used to drive a 30 kW IOT in CPI’s VIL410 Transmitter which drives a superconducting RF cavity [1].

Gain vs. frequency is shown with the input drive set for 300 W, 500 W, and 700 W at 1.3 GHz in Fig. 3. The 3-dB bandwidth is 200 MHz. Typical operating bandwidth is 50 MHz. Gain and phase pushing as a function of output power at 1.3 GHz are shown in Fig. 4. The shift in phase seen at 130 watts output may be an artefact of the measurement. A phase bridge was used for the phase measurements which has somewhat limited dynamic range. Output power and efficiency is shown vs. input RF power at 1.3 GHz in Fig. 5. The efficiency is calculated as RF power output divided by AC power input. The efficiency increases monotonically as the output power increases. The efficiency is 52% at 700 watts output power.

Typical pulsed operation is shown in Fig. 6. The leading and trailing edges (bottom) for the 10 msec pulse (top) are also shown in Fig. 6. The rise and fall time are approximately 20 ns.

Frequency spectra are shown in Figs. 7 and 8. Figure 7 shows the spectrum within a 2 MHz span of the 1.3 GHz operating frequency at 700 watts output power. Figure 8 shows the broad band spectrum at 700 watts output power. The frequency span is from 500 MHz to 6.5 GHz in Fig. 8. At 300 watts output power the second harmonic is 69 dB down from the carrier. At 500 watts output power the second harmonic is 66.8 dB down. As is seen in Fig. 8, the second harmonic is 64.5 dB down at 700 watts output power.

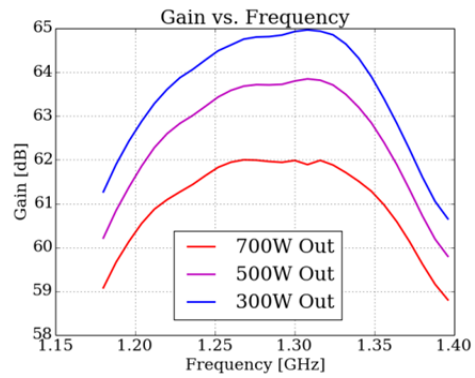

Figure 3: Gain vs. frequency at three output powers.

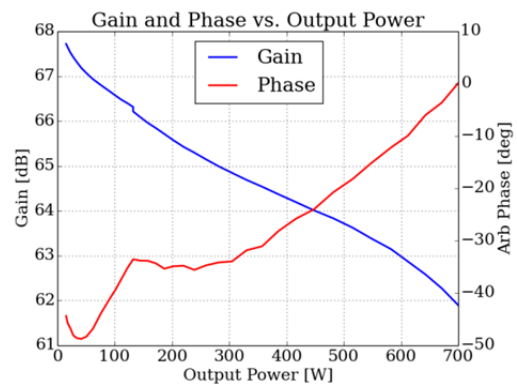

Figure 4: Gain and phase vs. output power.

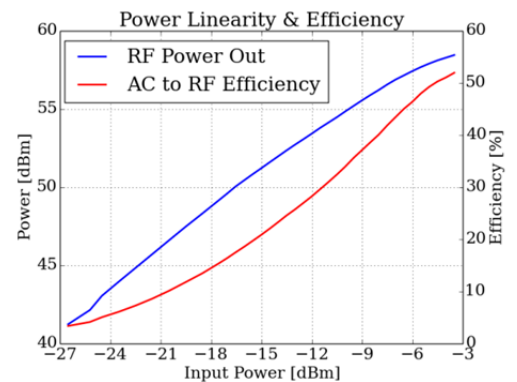

Figure 5: Output power and efficiency vs. input RF power.

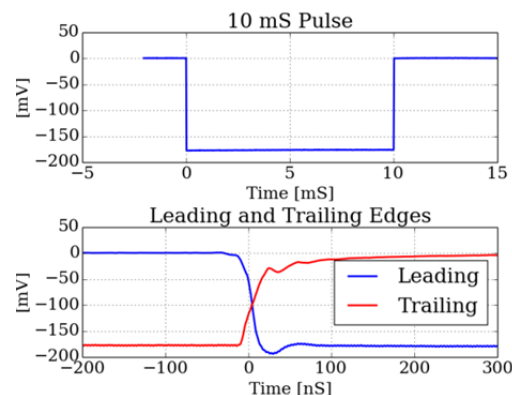

Figure 6: Pulse mode detected RF output.

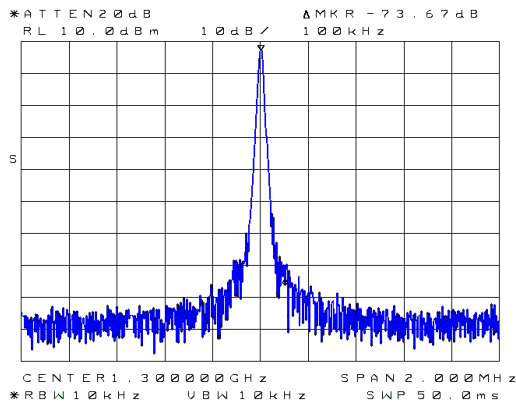

Figure 7: Spectrum near 1.3 GHz at 700 watts output.

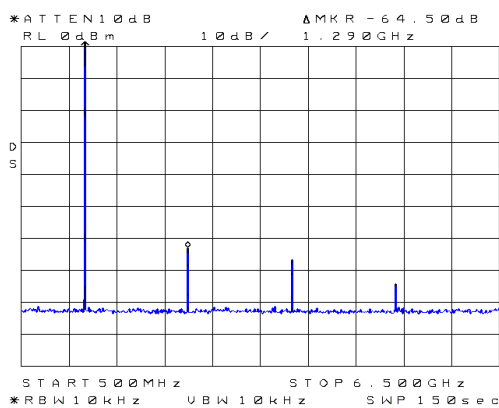

Figure 8: Broadband spectrum showing second, third, and fourth harmonics at 700 watts output power.

LIFE TEST DATA

A 1000-hour life test was performed at ambient temperature with a prototype VSL3616 operated at 700 watts CW into a matched load. The SSPA was cooled with $22 \pm 2^\circ\text{C}$ cooling water. The internal temperature of the SSPA was monitored throughout the 1000 hour life test. Phase and output power were monitored throughout the life test. The SSPA was stable throughout the 1000 hour test with a slight increase in the internal temperature evident over the last 400 hours. The prototype SSPA was disassembled and inspected after the life test. The output center conductor showed some evidence of thermal stress so a more robust connection was implemented in the production versions delivered with the VIL410 transmitters.

Figures 9 and 10 show the data recorded during the 1000 hour life test. Gain, coolant temperature, and internal temperature are plotted as functions of time in both Figs. 9 and 10. Power is plotted in Fig. 9 and phase is plotted in Fig. 10. The coolant water temperature fluctuated diurnally, resulting in power and phase fluctuations. With a suitably stable coolant water supply,

the SSPA meets all amplitude and phase stability requirements.

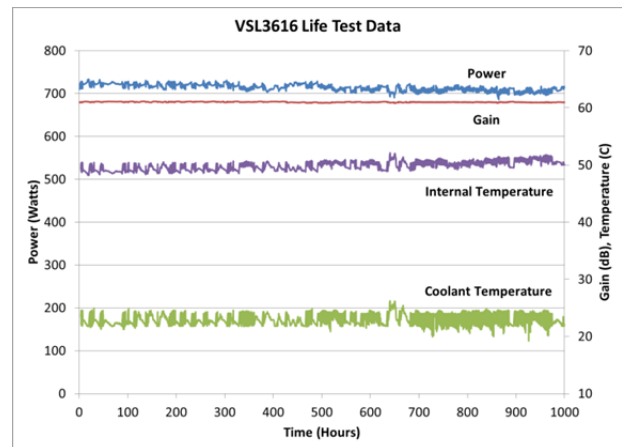

Figure 9: Power, gain and temperature over 1000 hours.

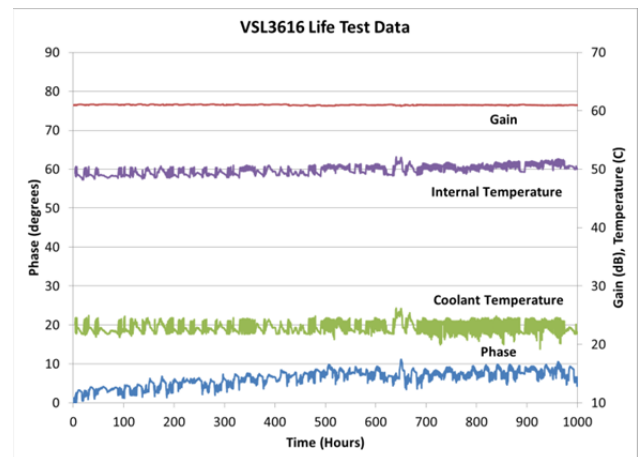

Figure 10: Phase, gain and temperature over 1000 hours.

CONCLUSION

CPI Beverly Microwave Division has developed a 700 watt CW, 1.3 GHz SSPA for use in accelerator applications. Two VSL3616 SSPAs have been successfully used to drive two 30 kW CW IOTs in the two VIL410 IOT transmitters recently delivered [1].

REFERENCES

- [1] I. Elkin et al., "VIL410, CPI'S 1.3 GHz, 25 kW CW IOT Amplifier System," *these proceedings*, WEPME023, IPAC'14, Dresden, Germany (2014).