

CHAPTER 1

PRE-INSTALLATION

CONTENTS:

1.1.0	INTRODUCTION	1-2
1.1.1	Generator Description	1-2
1.1.2	Features	1-2
1.1.3	Radiographic Performance	1-2
1.1.4	Environmental Specifications	1-3
1.1.5	Applicable Standards	1-3
1.1.6	Electromagnetic Compatibility (EMC)	1-7
1.1.7	RoHS Compliance	1-7
1.2.0	SAFETY	1-8
1.2.1	Safety and Warning Symbols	1-8
1.2.2	Safety Notices and Warnings	1-8
1.2.3	Safety Warning Labels	1-10
1.3.0	PREPARING FOR INSTALLATION	1-15
1.3.1	Generator Heat Output	1-15
1.3.2	Generator Power Requirements	1-15
1.3.3	Generator Ground Requirements	1-18
1.3.4	Locating and Mounting the Generator	1-19
1.3.5	Cable Entrance and Seismic Center Location	1-20
1.3.6	Tools and test Equipment Required	1-21
1.3.7	Pre-Installation Checklist	1-21
1.4.0	GENERATOR LAYOUT AND MAJOR COMPONENTS	1-22
1.5.0	COMPATIBILITY LISTING	1-24
1.6.0	CUSTOMER SUPPORT	1-25
1.7.0	COMPATIBILITY STATEMENT	1-25

Use and disclosure is subject to the restrictions on the title page of this CPI document.

1.1.0 INTRODUCTION

This chapter summarizes the main features of the CMP 200 X-ray generator (performance, regulatory and compatibility). Safety information is provided, along with environmental, room, and installation requirements. This chapter concludes with a pre-installation checklist and a diagram showing the major component layout.

The information in this chapter is provided in order for the installer to be able to plan the site layout prior to installation of the generator.

1.1.1 Generator Description

The CMP 200 X-ray generator is intended for use in stationary radiographic X-ray systems, including tomography. The X-ray generator consists of a main power cabinet, and a control console. The main power cabinet contains the HT tank and control circuits, the filament drivers, the low speed starter, and interface connections to the room equipment.

The control console allows the operator to select the technique factors, image receptors, etc., and to initiate an X-ray exposure.

1.1.2 Features

The following are the main features of and the options available for the generator:

- Integral low speed starter, compatible with X-ray tubes with type "R" stator. Optional compatibility with GE 23/23 Ω equal impedance "E" stator.
- 24 VDC, 110, or 220 VAC power source for Buckys.
- 24 VAC 150 watts power source for collimator lamp.
- 24 VDC 45 watts power source for system locks.
- Optional AEC.

1.1.3 Radiographic Performance

kVp range:	40 to 125 kV or 40 to 150 kV, depending on model.
kVp steps:	variable in 1 kV steps.
kVp accuracy:	$\pm 5\%$.
Risetime (10-90%):	<1.5 ms.
Time range:	1.0 to 6300 milliseconds.
mAs range	0.1 to 500 mAs (30/32/40 kW), 0.1 to 630 mAs (50 kW).
mAs accuracy:	$\pm (10\% + 0.2)$ mAs.
mA range	10 to 400 mA (30/32 kW), 10 to 500 mA (40 kW), 10 to 630 mA (50 kW).
Coefficient of linearity:	0.05 (station to station) mAs.
Coefficient of reproducibility:	kV, mAs ≤ 0.05 .

Use and disclosure is subject to the restrictions on the title page of this CPI document

1.1.4 Environmental Specifications

OPERATING

Ambient temperature range	10 to 40 °C (50 to 104 °F).
Relative humidity	20 to 80%, non-condensing.
Altitude	Sea-level to 2440 meters (700 to 1100 hPa).

TRANSPORT AND STORAGE

Ambient temperature range	-25 to 70 °C (-13 to 158 °F)..
Relative humidity	5 to 95%, non-condensing.
Atmospheric pressure range	500 to 1060 hPa (375 to 795 mm Hg).

1.1.5 Applicable Standards

The CMP 200 series of X-ray generators comply with the regulatory requirements and design standards in this section as follows:

- VZW2555 series: Only the standards marked with an asterisk * under **SAFETY**.
- VZW2556 series: All standards in this section.

A) SAFETY

- * FDA Center for Devices & Radiological Health (CDRH) - 21 CFR title 21 subchapter J (USA).
- * Radiation Emitting Devices Act - C34 (Canada).
- Medical Device Regulations (Canada).
- EC Directive 93/42/EEC concerning Medical Devices (European Community).
- * EN 60601-1/IEC 60601-1, EN 60601-2-7/IEC 60601-2-7, CSA 601.1, UL60601.1.
 - Type of protection against electric shock: Class I equipment.
 - Degree of protection against electric shock: Not classified.
 - Degree of protection against harmful ingress of water: Ordinary equipment.
 - Mode of operation: Continuous operation with intermittent loading (standby - exposure).
 - Equipment not suitable for use in presence of a flammable anesthetic mixture with air or with oxygen or nitrous oxide.
- EN 60601-1-4/IEC 60601-1-4, EN ISO 14971.

NOTE: All referenced standards are considered to be at the latest adopted revision.



The CE Mark is a declaration by the manufacturer that the product complies with the requirements of the applicable European Union (EU) medical device directive and that the product has been subject to conformity assessment procedures as provided in that directive.



A CSA mark with the indicators "C" and "US" means that product is certified for both the U.S. and Canadian markets, to the applicable U.S. and Canadian standards.

Use and disclosure is subject to the restrictions on the title page of this CPI document.

B) EMC (EN 60601-1-2:2001/IEC 60601-1-2:2001)

Guidance and manufacturer's declaration – electromagnetic emissions		
The VZW2556 series of X-ray generators is intended for use in the electromagnetic environment specified below. The customer or the user of the VZW2556 series should assure that it is used in such an environment.		
Emissions test	Compliance	Electromagnetic environment - guidance
RF emissions CISPR 11	Group 1	The VZW2556 series of X-ray generators use RF energy only for their internal functions. Therefore, the RF emissions are very low and are not likely to cause any interference in nearby electronic equipment.
RF emissions CISPR 11	Class A (The VZW2556 series of X-ray generators in combination with shielded location)	The VZW2556 series of X-ray generators must be used only in a shielded location with a minimum RF shielding effectiveness and, for each cable that exits the shielded location, a minimum RF filter attenuation of 40dB from 30 MHz to 230 MHz and 47dB from 230 MHz to 1 GHz. (The minimum at 30 MHz is 40dB and the minimum at 230 MHz is 47dB).
Harmonic emissions IEC 61000-3-2	Not Applicable	The VZW2556 series is suitable for use in all establishments other than domestic and those directly connected to the public low-voltage power supply network that supplies buildings used for domestic purposes.
Voltage fluctuations/ flicker emissions IEC 61000-3-3	Not Applicable	
NOTE It is essential that the actual shielding effectiveness and filter attenuation of the shielded location be verified to assure that they meet the minimum specifications.		

Use and disclosure is subject to the restrictions on the title page of this CPI document

1.1.5 Applicable Standards (Cont)

Guidance and manufacturer's declaration – electromagnetic immunity			
The VZW2556 series of X-ray generators is intended for use in the electromagnetic environment specified below. The customer or the user of the VZW2556 series should assure that it is used in such an environment.			
Immunity test	IEC 60601 test level	Compliance level	Electromagnetic environment – guidance
Electrostatic discharge (ESD) IEC 61000-4-2	± 6 kV contact ± 8 kV air	± 6 kV contact ± 8 kV air	Floors should be wood, concrete or ceramic tile. If floors are covered with synthetic material, the relative humidity should be at least 30%.
Electrical fast transient/burst IEC 61000-4-4	± 2 kV for power supply lines ± 1 kV for input/output lines	± 2 kV for power supply lines ± 1 kV for input/output lines	Mains power quality should be that of a typical commercial or hospital environment.
Surge IEC 61000-4-5	± 1 kV differential mode ± 2 kV common mode	± 1 kV differential mode ± 2 kV common mode	Mains power quality should be that of a typical commercial or hospital environment.
Voltage dips, short interruption, and voltage variations on power supply input lines IEC 61000-4-11	< 5 % U_T (> 95 % dip in U_T) for 0.5 cycle 40 % U_T (60 % dip in U_T) for 5 cycles 70 % U_T (30 % dip in U_T) < 5 % U_T (> 95 % dip in U_T) for 5 s	< 5 % U_T (> 95 % dip in U_T) for 0.5 cycle 40 % U_T (60 % dip in U_T) for 5 cycles 70 % U_T (30 % dip in U_T) < 5 % U_T (> 95 % dip in U_T) for 5 s	Mains power quality should be that of a typical commercial or hospital environment. If the user of the VZW2556 series X-ray generator requires continued operation during power mains interruptions, it is recommended that the X-ray generator be powered from an uninterruptible power supply or battery.
Power frequency (50/60 Hz) IEC 61000-4-8	3 A/m	3 A/m	Power frequency magnetic fields should be at levels characteristic of a typical location in a typical commercial or hospital environment
NOTE: U_T is the A.C. mains voltage prior to application of the test level.			

Use and disclosure is subject to the restrictions on the title page of this CPI document.

1.1.5 Applicable Standards (Cont)

Guidance and manufacturer's declaration – electromagnetic immunity			
The VZW2556 series of X-ray generators is intended for use in the electromagnetic environment specified below. The customer or the user of the VZW2556 series should assure that it is used in such an environment.			
Immunity test	IEC 60601 test level	Compliance level	Electromagnetic environment - guidance
Conducted RF IEC 61000-4-6	3 V _{rms} 150 kHz to 80MHz	3 V _{rms} 150 kHz to 80MHz	The VZW2556 series of X-ray generators must be used only in a shielded location with a minimum RF shielding effectiveness and, for each cable that enters the shielded location, a minimum RF filter attenuation of 40dB from 30 MHz to 230 MHz and 47dB from 230 MHz to 1 GHz. (The minimum at 30 MHz is 40dB and the minimum at 230 MHz is 47dB.) Field strengths outside the shielded location from fixed RF transmitters, as determined by an electromagnetic site survey, should be less than 3 V/m. ^a Interference may occur in the vicinity of equipment marked with the following symbol: 
Radiated RF IEC 61000-4-3	3 V/m 80MHz to 2.5 GHz	3 V/m 80MHz to 2.5 GHz	
<p>NOTE 1 These guidelines may not apply all situations. Electromagnetic propagation is affected by absorption and reflection from structures, objects and people.</p> <p>NOTE 2 It is essential that the actual shielding effectiveness and filter attenuation of the shielded location be verified to assure that they meet the minimum specification.</p> <p>^a Field strengths from fixed transmitters, such as base stations for radio (cellular/cordless) telephones and land mobile radios, amateur radio, AM and FM radio broadcast and TV broadcast cannot be predicted theoretically with accuracy. To assess the electromagnetic environment due to fixed RF transmitters, an electromagnetic site survey should be considered. If the measured field strength in the location in which the VZW2556 series of X-ray generators is used exceeds the applicable RF compliance level above, the X-ray generator should be observed to verify normal operation. If abnormal performance is observed, additional measures may be necessary, such as re-orienting or relocating the X-ray generator.</p>			

Use and disclosure is subject to the restrictions on the title page of this CPI document

1.1.6 Electromagnetic Compatibility (EMC)

In accordance with the intended use, some models of this series of X-ray generators comply with the European Council Directive concerning Medical Devices. The CE marking affixed to compliant products signifies this. One of the harmonized standards of this Directive defines the permitted levels of electromagnetic emission from this equipment and its required immunity from the electromagnetic emissions of other devices.

It is not possible, however, to exclude with absolute certainty the possibility that other high frequency electronic equipment, which is fully compliant to the EMC regulations, will not adversely affect the operation of this generator. If the other equipment has a comparatively high level of transmission power and is in close proximity to the generator, these EMC concerns (the risk of interference) may be more pronounced. It is therefore recommended that the operation of equipment of this type such as mobile telephones, cordless microphones and other similar mobile radio equipment be restricted from the vicinity of this X-ray generator.

1.1.7 RoHS Compliance

CMP 200

产品中有毒有害物质或元素的名称及含量

Table of hazardous substances' name and concentration.

部件名称 Component Name	有毒有害物质或元素 Hazardous substances' name					
	铅 (Pb)	汞 (Hg)	镉 (Cd)	六价铬 (Cr(VI))	多溴联苯 (PBB)	多溴二苯醚 (PBDE)
Generator	X	O	O	X	O	O
Console	X	O	O	X	O	O

O: 表示该有毒有害物质在该部件所有均质材料中的含量均在SJ/T11363-2006 标准规定的限量要求以下
X: 表示该有毒有害物质至少在该部件的某一均质材料中的含量超出SJ/T11363-2006 标准规定的限量要求

- 此表所列数据为发布时所能获得的最佳信息
- 由于缺少经济上或技术上合理可行的替代物质或方案，此医疗设备运用以上一些有毒有害物质来实现设备的预期临床功能，或给人员或环境提供更好的保护效果。

O: Indicates that this toxic or hazardous substance contained in all of the homogeneous materials for this part is below the limit requirement in SJ/T11363-2006.
X: Indicates that this toxic or hazardous substance contained in at least one of the homogeneous materials used for this part is above the limit requirement in SJ/T11363-2006.



- Data listed in the table represents best information available at the time of publication
- Applications of hazardous substances in this medical device are required to achieve its intended clinical uses, and/or to provide better protection to human beings and/or to environment, due to lack of reasonably (economically or technically) available substitutes.

Use and disclosure is subject to the restrictions on the title page of this CPI document.

1.2.0 SAFETY

1.2.1 Safety and Warning Symbols

The following advisory symbols are used on the safety warning labels, and/or on circuit boards, and/or on the operator console.

	<p>High voltage symbol used to indicate the presence of high voltage.</p>
	<p>Warning symbol used to indicate a potential hazard to operators, service personnel or to the equipment. It indicates a requirement to refer to the accompanying documentation for details.</p>
	<p>Radiation exposure symbol used on operator console. Lights to indicate that an exposure is in progress. This is accompanied by an audible tone from the console.</p>
<p>WARNING THIS X-RAY UNIT MAY BE DANGEROUS TO PATIENT AND OPERATOR UNLESS SAFE EXPOSURE FACTORS, OPERATING INSTRUCTIONS AND MAINTENANCE SCHEDULES ARE OBSERVED.</p>	<p>Radiation warning label on operator console. Never allow unqualified personnel to operate the X-ray generator.</p>

1.2.2 Safety Notices and Warnings

WARNING: THIS X-RAY UNIT MAY BE DANGEROUS TO PATIENT AND OPERATOR UNLESS SAFE EXPOSURE FACTORS, OPERATING INSTRUCTIONS AND MAINTENANCE SCHEDULES ARE OBSERVED.

WARNING: PROPER USE AND SAFE OPERATING PRACTICES WITH RESPECT TO X-RAY GENERATORS ARE THE RESPONSIBILITY OF USERS OF SUCH GENERATORS. CPI CANADA INC. PROVIDES INFORMATION ON ITS PRODUCTS AND ASSOCIATED HAZARDS, BUT ASSUMES NO RESPONSIBILITIES FOR AFTER-SALE OPERATING AND SAFETY PRACTICES.

THE MANUFACTURER ACCEPTS NO RESPONSIBILITY FOR ANY GENERATOR NOT MAINTAINED OR SERVICED ACCORDING TO THIS SERVICE AND INSTALLATION MANUAL, OR FOR ANY GENERATOR THAT HAS BEEN MODIFIED IN ANY WAY.

THE MANUFACTURER ALSO ASSUMES NO RESPONSIBILITY FOR X-RAY RADIATION OVEREXPOSURE OF PATIENTS OR PERSONNEL RESULTING FROM POOR OPERATING TECHNIQUES OR PROCEDURES.

Use and disclosure is subject to the restrictions on the title page of this CPI document

1.2.2 Safety Notices and Warnings (Cont)

X-ray radiation exposure may be damaging to health, with some effects being cumulative and extending over periods of many months or even years. **Operators and service personnel should avoid any exposure to the primary beam** and take protective measures to safeguard against scatter radiation. Scatter radiation is caused by any object in the path of the primary beam and may be of equal or less intensity than the primary beam that exposes the film.

No practical design can incorporate complete protection for operators or service personnel who do not take adequate safety precautions. **Only authorized and properly trained service and operating personnel should be allowed to work with this X-ray generator equipment.** The appropriate personnel must be made aware of the inherent dangers associated with the servicing of high voltage equipment and the danger of excessive exposure to X-ray radiation during system operation.



DO NOT CONNECT UNAPPROVED EQUIPMENT TO THE REAR OF THE CONSOLE.

For the membrane console, J3 is for connection of an external hand switch, J4 is a serial port for use by an external computer, and J8 is for the interconnect cable to the main cabinet.

For the touch screen console, J2 on the touch screen interface board is for the interconnect cable to the generator, J3 is for connection of an external hand switch, J5 connects to the membrane switch assembly with the on / off and prep / expose switches, and J4 is a serial port for use by an external computer.

INCORRECT CONNECTIONS OR USE OF UNAPPROVED EQUIPMENT MAY RESULT IN INJURY OR EQUIPMENT DAMAGE.

CAUTION: DO NOT EXCEED THE TUBE MAXIMUM OPERATING LIMITS. INTENDED LIFE AND RELIABILITY WILL NOT BE OBTAINED UNLESS GENERATORS ARE OPERATED WITHIN PUBLISHED SPECIFICATIONS.

Use and disclosure is subject to the restrictions on the title page of this CPI document.

1.2.2 Safety Notices and Warnings (Cont)

WARNING: HAZARDOUS VOLTAGES EXIST INSIDE THE GENERATOR WHENEVER THE MAIN POWER DISCONNECT IS SWITCHED ON. THESE AREAS INCLUDE, BUT ARE NOT LIMITED TO, THE MAIN FUSE HOLDER AND ASSOCIATED CIRCUITS ON THE H.V. AUXILIARY BOARD, THE AUXILIARY AND / OR TOUCHSCREEN TRANSFORMERS, AND THE MAIN POWER CONTACTOR.
LED DS1 ON THE H.V. AUXILIARY BOARD INDICATES THE PRESENCE OF THE +24 VDC SUPPLY.
THE CONSOLE ON/OFF SWITCH DOES NOT DISCONNECT THE MAIN POWER FROM THE ABOVE AREAS INSIDE THE GENERATOR.
THE DC BUS CAPACITORS, LOCATED IN THE MAIN CABINET PRESENT A SAFETY HAZARD FOR AT LEAST 5 MINUTES AFTER THE POWER HAS BEEN REMOVED FROM THE UNIT. CHECK THAT THESE CAPACITORS ARE DISCHARGED BEFORE SERVICING THE GENERATOR.
AN LED CONNECTED ACROSS THE DC BUS INDICATES THE PRESENCE OF HIGH VOLTAGE. THIS LED IS MOUNTED ON THE EMC CAPACITOR BOARD (ON SOME MODELS, THE EMC CAPACITOR BOARD DOES NOT CONTAIN ANY COMPONENTS OTHER THAN THE LED AND THE SERIES RESISTORS).
DO NOT RELY SOLELY ON BLEEDER CIRCUITS AND HIGH-VOLTAGE ON INDICATORS IN THE GENERATOR TO PROTECT YOU. DUE TO THE POSSIBILITY OF COMPONENT FAILURE, IT MUST NEVER BE ASSUMED THAT AN UNLIT LED ENSURES THAT NO HIGH VOLTAGE IS PRESENT. USING A VOLTMETER, CONFIRM THAT NO HIGH VOLTAGE IS PRESENT BEFORE ATTEMPTING ANY SERVICE.

1.2.3 Safety Warning Labels

This subsection defines the safety labels used inside and outside the generator cabinet.

NOTE: THESE LABELS AND WARNINGS ARE PROVIDED TO ALERT SERVICE PERSONNEL THAT SERIOUS INJURY WILL RESULT IF THE HAZARD IDENTIFIED IS IGNORED.

WARNING: SWITCH OFF THE MAIN POWER DISCONNECT AND ALLOW SUFFICIENT TIME FOR ALL CAPACITORS TO DISCHARGE BEFORE REMOVING ANY COVERS.

WARNING: IF ANY COVERS MUST BE REMOVED FOR SERVICE, TAKE ALL REQUIRED PRECAUTIONS WITH RESPECT TO THE HAZARD(S) AND IMMEDIATELY REPLACE THE COVERS WHEN THE NEED FOR REMOVAL IS COMPLETED.

This information is provided to help you establish safe operating conditions for both you and your X-ray generator. Do not operate this X-ray generator except in accordance with these instructions, and any additional information provided by the X-ray generator manufacturer and / or competent safety authorities.

Use and disclosure is subject to the restrictions on the title page of this CPI document

1.2.3 Safety Warning Labels (Cont)

Weight Label

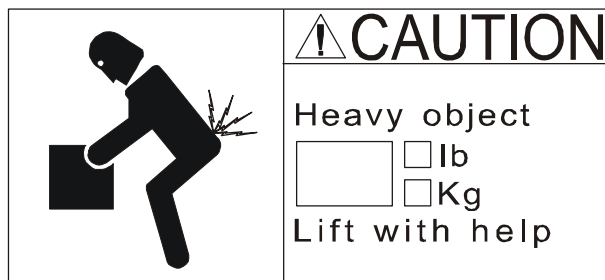

This label is attached to the main generator cabinet and to the HT tank, and states the approximate weight of the main cabinet with the HT tank, and the weight of the HT tank separately. Do not attempt to lift these items without proper assistance.

Caution HV/High Energy Warning Label

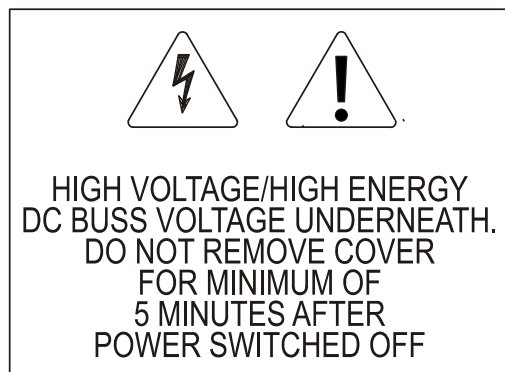

This label is attached to the generator cabinet and on the inside of the back cover above the HT tank. The DC bus capacitors (approximately 300 to 670 VDC, depending on model) will remain charged for up to 5 minutes after the AC mains is disconnected or the console is switched off.

Use and disclosure is subject to the restrictions on the title page of this CPI document.

1.2.3 Safety Warning Labels (Cont)

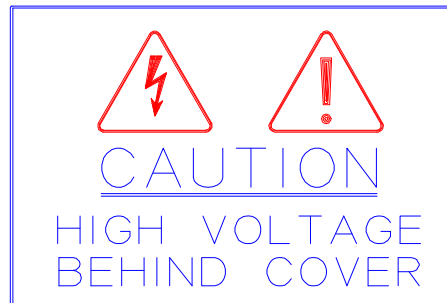
Caution HV Behind Cover Label

This label is attached to the outside of the generator cabinet, to the cover over the inverter assembly, and to the cover in front of the touchscreen fusing board. Mains voltage is present inside the cabinet whenever the main disconnect is switched on. Additionally, the DC bus capacitors will remain charged for up to 5 minutes after the AC mains is disconnected or the console is switched off.

WARNING: *WAIT A MINIMUM OF 5 MINUTES AFTER THE INPUT MAINS POWER HAS BEEN REMOVED BEFORE REMOVING ANY COVERS. ONCE THE COVER(S) ARE REMOVED. CHECK THAT THE VOLTAGE ACROSS THE DC BUS CAPACITORS IS NEAR ZERO BEFORE SERVICING. IF THIS VOLTAGE EXCEEDS 48 VDC, THE CAPACITORS MUST BE MANUALLY DISCHARGED BY QUALIFIED SERVICE PERSONNEL.*

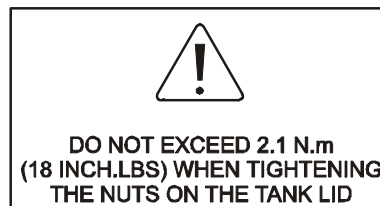
HT Tank - Transformer Terminals Notice

This notice is printed on the HT tank lid and cautions against over-tightening the nuts on the transformer feedthrough terminals (for the primary of the HT transformers).

Use and disclosure is subject to the restrictions on the title page of this CPI document

1.2.3 Safety Warning Labels (Cont)

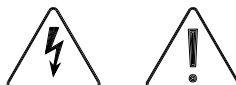
Danger High Tension Notice**DANGER
HIGH TENSION**

This notice is printed on the HT tank lid. High voltage may be present at the primary terminals on the tank lid board, at the output high voltage connectors, and at the mA/mAs measuring jacks if the shorting link is opened for mA/mAs measurements.



HIGH VOLTAGE HAZARD: Be certain that you are aware of all potential high voltage locations and hazards as detailed in this section before removing any covers, or attempting any service on this X-ray generator.

**FUSE RATINGS:**LOCATION1 PHASE UNITS3 PHASE UNITS

MAIN LINE FUSES:

F1, F2: FRN-R-50 *

F1, F2, F3: AG40 * for
32/40 kW 400/480 V
units).
SC60 * for 32/40 kW
208-230 V 3 phase
units).
SC60 *for all 50 kW
units.

GENERATOR CONTROL BOARD:
CONSOLE BOARD:

F1: GDC-1A *
F1: GDC-1A *

F1: GDC-1A *
F1: GDC-1A *

H.V. AUXILIARY BOARD:

ALL 208/230 V UNITSALL 400/480 V UNITS

F1, F6, F7: S506-8A *
F2, F3: GDC-5A *
F4, F5, F11: GDC-6.3A *
F8, F9, F12: GDC-2A *
F10: GDC-1A *

F1, F6, F7: S506-8A *
F2, F3: GDC-5A *
F4, F5: FNQ-1 *
F8, F9: FNQ 2 *
F10: GDC-1A *
F11: GDC-6.3A *
F12: GDC-2A *

* Refer to chapter 8, spares list, for CPI part number for these fuses.

Use and disclosure is subject to the restrictions on the title page of this CPI document.

1.2.3 Safety Warning Labels (Cont)



HIGH VOLTAGE HAZARD: Approximately 400 VAC is present on the console board in the area of T1, C36, and J5. This is a high voltage source for the fluorescent backlight on the LCD display.

HIGH VOLTAGE HAZARD: AC mains voltage and / or DC bus voltage (approximately 325 to 670 VDC, depending on model) is present on the H.V. auxiliary board whenever the AC mains is energized. Ensure that the AC mains is switched off and locked out before servicing this board. See the note below regarding the DC bus voltage.

HIGH VOLTAGE HAZARD: High voltage is present on all components connected to the AC mains (line fuses, main power contactor, H.V. auxiliary board, auxiliary and / or touchscreen transformer, etc) whenever the AC mains is switched on. Additionally, DC bus voltage is present on certain components (mains rectifier assembly, DC bus capacitors, inverter assembly, HT tank, H.V. auxiliary board, etc) whenever the generator is switched on, and will remain on for up to 5 minutes after the console is switched off or the AC mains is switched off or disconnected.



High voltage (approximately 325 to 670 VDC, depending on model) is present on the inverter assembly and associated components whenever the AC mains is energized and the console is switched on, and for up to 5 minutes after the console is switched off or the AC mains is disconnected. **THIS COMBINATION OF HIGH VOLTAGE AND HIGH CURRENT IS POTENTIALLY LETHAL. USE EXTREME CAUTION WHEN SERVICING THIS UNIT.**

1.3.0 PREPARING FOR INSTALLATION

1.3.1 Generator Heat Output

The maximum heat output of the main generator cabinet is less than 1000 BTU / hour in normal clinical use, with a maximum of 70 BTU / hour heat output for the console. The console is primarily conduction cooled, and the main cabinet is fan cooled. The console and main cabinet should never be covered when the generator is switched on, as any covering may interfere with the cooling.

1.3.2 Generator Power Requirements

The tables in this section show mains power requirements for various configurations of CMP 200 X-ray generators. The installer must ensure that the generator is connected to the proper mains voltage as per the nameplate on the generator.

The table below depicts the power requirements for the 30 kW CMP 200 X-ray generators.

Line Voltage	208 VAC - 5% to 230 VAC + 10%, 1 phase.
Line Frequency	50/60 Hz.
Momentary Current	185 Amps at 230 VAC.
Nominal Current *	≤5 Amps.
Momentary Power Consumption	45 kVA.

The table below depicts the power requirements for the 32 kW CMP 200 X-ray generators.

Line Voltage	208 VAC - 5% to 230 VAC + 10%, 3 phase. 400 VAC ± 10%, 3 phase. 480 VAC ± 10%, 3 phase.
Line Frequency	50/60 Hz.
Momentary Current	110 Amps/phase at 230 VAC. 65 Amps/phase at 400 VAC. 55 Amps/phase at 480 VAC.
Nominal Current *	≤5 Amps.
Momentary Power Consumption	45 kVA.

Use and disclosure is subject to the restrictions on the title page of this CPI document.

1.3.2 Generator Power Requirements (Cont)

The table below depicts the power requirements for the 40 kW CMP 200 X-ray generators.

Line Voltage	208 VAC - 5% to 230 VAC + 10%, 1 phase. 208 VAC - 5% to 230 VAC + 10%, 3 phase. 400 VAC \pm 10%, 3 phase. 480 VAC \pm 10%, 3 phase.
Line Frequency	50/60 Hz.
Momentary Current	250 Amps at 230 VAC (1 phase). 135 Amps/phase at 230 VAC (3 phase). 80 Amps/phase at 400 VAC. 65 Amps/phase at 480 VAC.
Nominal Current *	\leq 5 Amps.
Momentary Power Consumption	55 kVA.

The table below depicts the power requirements for the 50 kW CMP 200 X-ray generators.

Line Voltage	208 VAC - 5% to 230 VAC + 10%, 3 phase. 400 VAC \pm 10%, 3 phase. 480 VAC \pm 10%, 3 phase.
Line Frequency	50/60 Hz.
Momentary Current	170 Amps/phase at 230 VAC. 100 Amps/phase at 400 VAC. 80 Amps/phase at 480 VAC.
Nominal Current *	\leq 5 Amps.
Momentary Power Consumption	65 kVA.

* Nominal Current = Generator standby current only. External or installer-supplied equipment connected to the generator may increase the nominal current beyond the values shown.

1.3.2 Generator Power Requirements (Cont)

The following table defines the power line requirements for the generators.

NOTE: THE FOLLOWING TABLE CONTAINS RECOMMENDED VALUES FOR THE WIRE SIZES BETWEEN THE MAINS DISCONNECT AND THE GENERATOR. THE ACTUAL VALUES USED AT AN INSTALLATION ARE DEPENDENT ON THE QUALITY OF THE INPUT LINE (VOLTAGE LEVEL), THE CURRENT REQUIREMENTS, AND THE LENGTH OF THE CABLE RUN, AND MUST BE CONFIRMED BY THE INSTALLER.

FINAL SELECTION OF GENERATOR INPUT WIRE AND DISCONNECTS AS WELL AS THE CABLING FROM THE DISTRIBUTION TRANSFORMER TO THE MAINS DISCONNECT MUST MEET THE REQUIREMENTS OF THE LOCAL ELECTRICAL CODES, AND IS USUALLY DETERMINED BY HOSPITAL / CONTRACTOR ENGINEERING.

THE RATINGS LISTED CONSIDER THE GENERATOR REQUIREMENTS ONLY. THE INSTALLER MUST MAKE THE NECESSARY COMPENSATION FOR ADDITIONAL LOAD REQUIREMENTS.

A POOR QUALITY INPUT LINE MAY RESULT IN THE INSTALLER HAVING TO DERATE THE GENERATOR'S MAXIMUM POWER.

Generator Series and Mains Voltage	Minimum Recommended Mains Disconnect to Generator (15 ft/5 m max)	Generator Momentary Line Current	Minimum Recommended Generator Service Rating	Minimum Recommended Distribution Transformer Rating	Minimum Recommended Ground Wire Size *	Apparent Mains Resistance
30 kW 208-230 VAC, 1p.	#4 (21 mm ²)	185 A	120 A	45 kVA	#4 (21 mm ²)	0.06 Ω
32 kW 208-230 VAC, 3p.	#4 (21 mm ²)	110 A	100 A	45 kVA	#4 (21 mm ²)	0.09 Ω
32 kW 400 VAC, 3p.	#6 (13.3 mm ²)	65 A	100 A	45 kVA	#6 (13.3 mm ²)	0.27 Ω
32 kW 480 VAC, 3p.	#6 (13.3 mm ²)	55 A	100 A	45 kVA	#6 (13.3 mm ²)	0.4 Ω
40 kW 208-230 VAC, 1p.	#2 (33 mm ²)	250 A	120 A	65 kVA	#2 (33 mm ²)	0.045 Ω
40 kW 208-230 VAC, 3p.	#4 (21 mm ²)	135 A	100 A	55 kVA	#4 (21 mm ²)	0.075 Ω
40 kW 400 VAC, 3p.	#6 (13.3 mm ²)	80 A	100 A	55 kVA	#6 (13.3 mm ²)	0.22 Ω
40 kW 480 VAC, 3p.	#6 (13.3 mm ²)	65 A	100 A	55 kVA	#6 (13.3 mm ²)	0.32 Ω
50 kW 208-230 VAC, 3p.	#4 (21 mm ²)	170 A	100 A	65 kVA	#4 (21 mm ²)	0.055 Ω
50 kW 400 VAC, 3p.	#6 (13.3 mm ²)	100 A	100 A	65 kVA	#6 (13.3 mm ²)	0.17 Ω
50 kW 480 VAC, 3p.	#6 (13.3 mm ²)	80 A	100 A	65 kVA	#6 (13.3 mm ²)	0.24 Ω

* Refer to 1.3.3 for general grounding information.

Use and disclosure is subject to the restrictions on the title page of this CPI document.

1.3.2 Generator Power Requirements (Cont)

Recommended Service Disconnect: As per the above table

- All wiring and grounding should comply with the national electrical code or equivalent.
- All wiring must be copper.
- The disconnect switch shall be located within reach of the operator.

1.3.3 Generator Ground Requirements

- A suitable ground must be connected from the disconnect switch to the main ground of the generator, located to the right of the main fuse block. The ground wire is typically part of the line cord, and the current capacity of the ground conductor must normally be equal to or greater than that of the line conductors.
- A copper ground cable, #10 AWG (6 mm²) or larger should be connected from the X-ray tube housing to the H.T. tank ground stud (located at the top of the HT tank).
- If a neutral line is provided with the system, under no circumstances is it to be used for ground purposes. The ground must carry fault currents only.

Use and disclosure is subject to the restrictions on the title page of this CPI document

1.3.4 Locating and Mounting the Generator

The main generator cabinet is self-standing and does not need to be supported. However, the installation should meet the following requirements:

- The floor must be flat and level.
- The generator installation area must be clean and free of dirt or debris.
- The installer must supply generator hold-down brackets, if required. Alternately, mounting holes may be drilled in the base of the generator. The generator may then be anchored to the floor via these holes.
- Sufficient room must be provided to allow access to the rear and side of the generator for installation and service. See figure 1-1 for recommended clearances.
- A cable trough, conduit, or raceway (1 in; 2.5 mm, diameter) should be provided from the control console to the main cabinet to allow routing of the control cable if required.
- The control console is normally freestanding on a desk or shelf. It may be anchored if necessary.

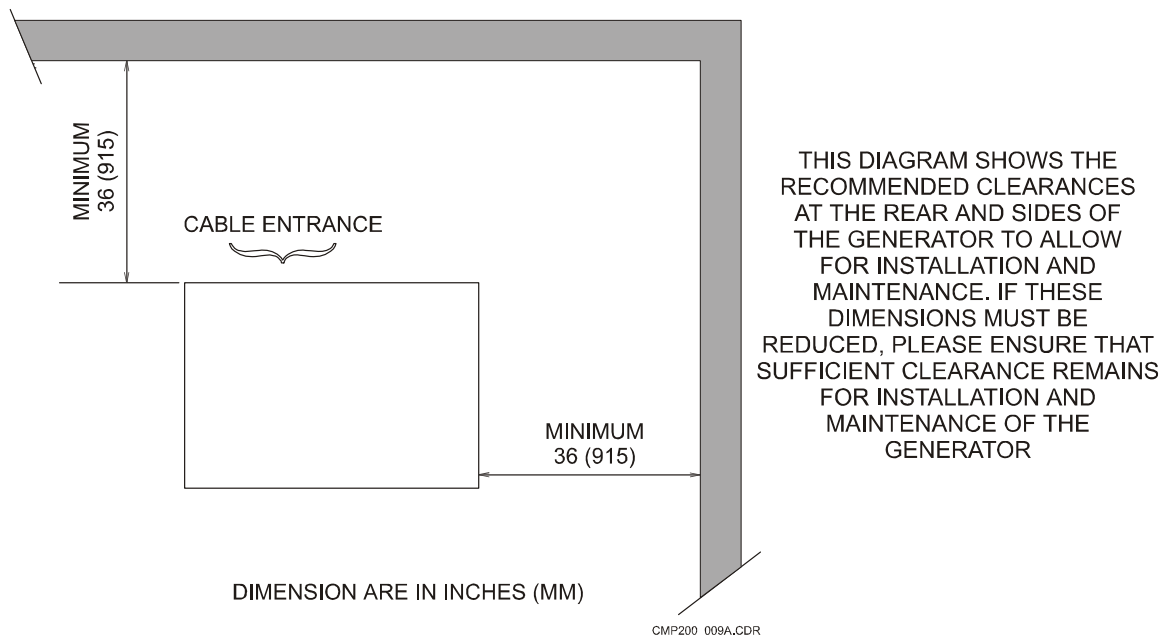
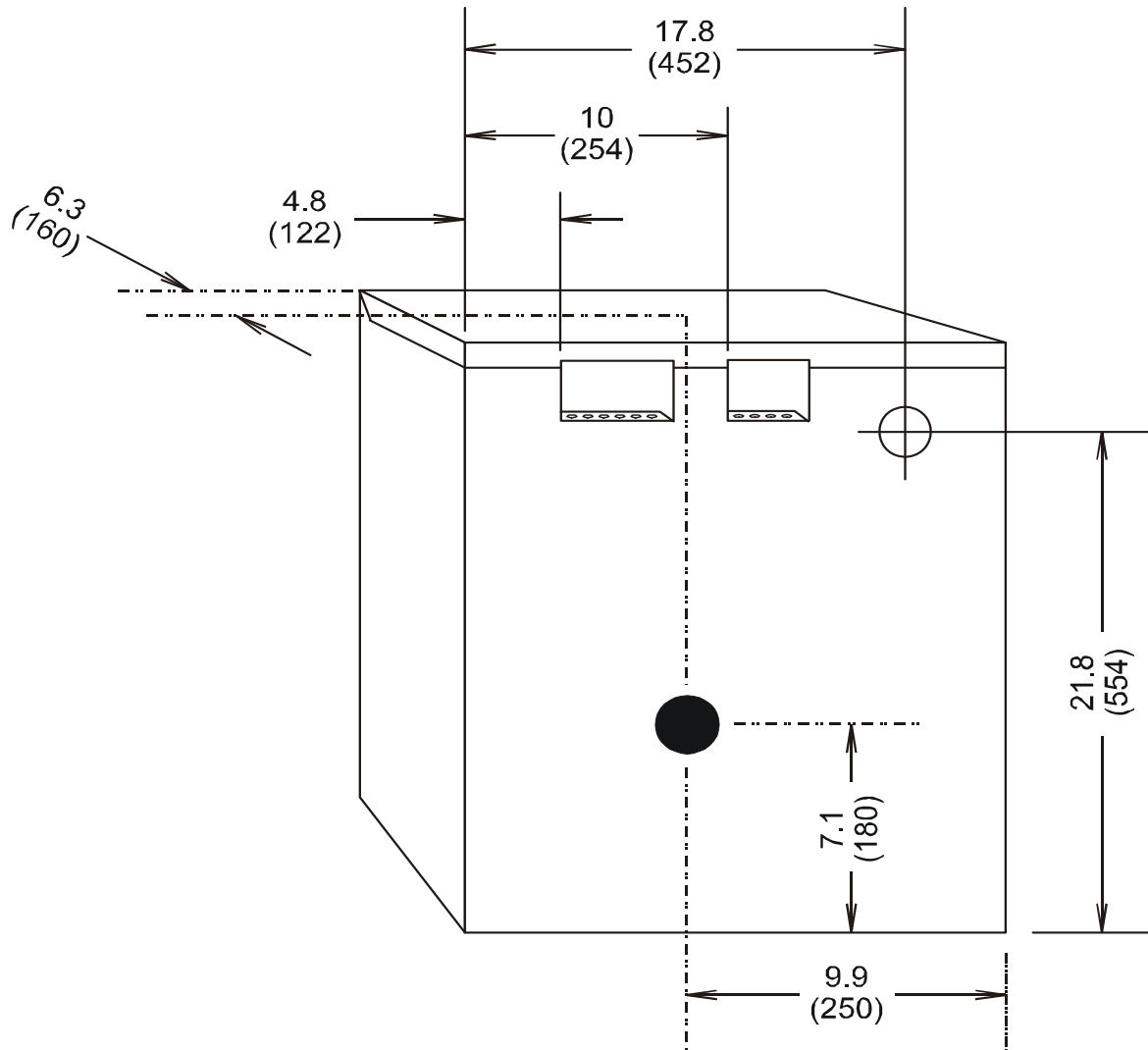

Figure 1-1: Generator clearances

Use and disclosure is subject to the restrictions on the title page of this CPI document.

1.3.5 Cable Entrance and Seismic Center Location

Figure 1-2 shows the locations of the cable access slots, the AC mains cable entry, and the seismic center location for the CMP 200 X-ray generator.



DIMENSIONS ARE IN INCHES (MM)

CMP200_013A.CDR

Figure 1-2: CMP 200 cable entry locations and seismic center

Use and disclosure is subject to the restrictions on the title page of this CPI document

1.3.6 Tools and test Equipment Required

The following is a checklist of recommended tools and test equipment for installation and calibration of the generator.

CHECK <input type="checkbox"/>	DESCRIPTION
<input type="checkbox"/>	General hand tools for installation: Wrenches, nut drivers, assortment of screwdrivers, pliers, etc.
<input type="checkbox"/>	If the generator is to be anchored to the floor, suitable tools (i.e. drill, drill bits, etc) and mounting hardware must be available.
<input type="checkbox"/>	A supply of connectors for wiring: terminal lugs, caps, splices etc.
<input type="checkbox"/>	A calibrated DVM that indicates true RMS voltages.
<input type="checkbox"/>	Dual trace memory oscilloscope with a minimum 20 MHz bandwidth; appropriate leads, probes, etc.
<input type="checkbox"/>	Device for measuring true kVp. This may be a Dynalyzer equivalent or a non-invasive meter such as the Keithley TRIAD system.
<input type="checkbox"/>	A calibrated radiation meter with detectors that will allow for R/min and uR type measurements (or uGy and Gy/min).
<input type="checkbox"/>	A suitable mA / mAs meter.
<input type="checkbox"/>	A strobe or reed type tachometer to verify that the anode is rotating up to speed.
<input type="checkbox"/>	A sufficient selection of absorbers to allow AEC calibration if this option is fitted. A suggested selection is Lexan in thickness of 5.0, 10.0, and 15.0 cm, or water in plastic containers of homogenous density in thickness of 5.0, 10.0, and 15.0 cm.
<input type="checkbox"/>	Vapor proof compound for the HT terminations.

1.3.7 Pre-Installation Checklist

Before starting the generator installation, review the following checklist.

CHECK <input type="checkbox"/>	DESCRIPTION
<input type="checkbox"/>	Is there an unloading area to transport the generator from the delivery truck to the inside of the building?
<input type="checkbox"/>	If the installation is not on the same floor as the delivery entrance, is there an elevator available?
<input type="checkbox"/>	Is there a transport dolly or similar device to move the generator?
<input type="checkbox"/>	Do any regulatory bodies need to be notified prior to installation?
<input type="checkbox"/>	If movers are required, have arrangements for time and equipment been completed?
<input type="checkbox"/>	Are lifting straps or some other suitable device available to lift the generator off the shipping pallet?

Use and disclosure is subject to the restrictions on the title page of this CPI document.

1.4.0 GENERATOR LAYOUT AND MAJOR COMPONENTS

The dimensions and weight of the generator are shown in the table below.

ITEM	LENGTH	WIDTH	HEIGHT	WEIGHT
Main cabinet in shipping pack	30.5 (775)	21.5 (546)	38 (965)	129 (59)
Main cabinet unpacked	22.8 (580)	13.7 (348)	24.3 (617)	113 (51)
Control console	12.3 (313)	10.9 (277)	3.7 (94)	6 (2.72)

The above dimensions are inches (mm), weights are in pounds (Kg).

Figures 1-3 and 1-4 show the major components located inside the generator cabinet. Figure 1-5 is an internal view of the console, showing the major components and cabling. Figure 1-3 does not show the fan-mounting bracket, nor does it represent all models. This is meant to show major component layout only.

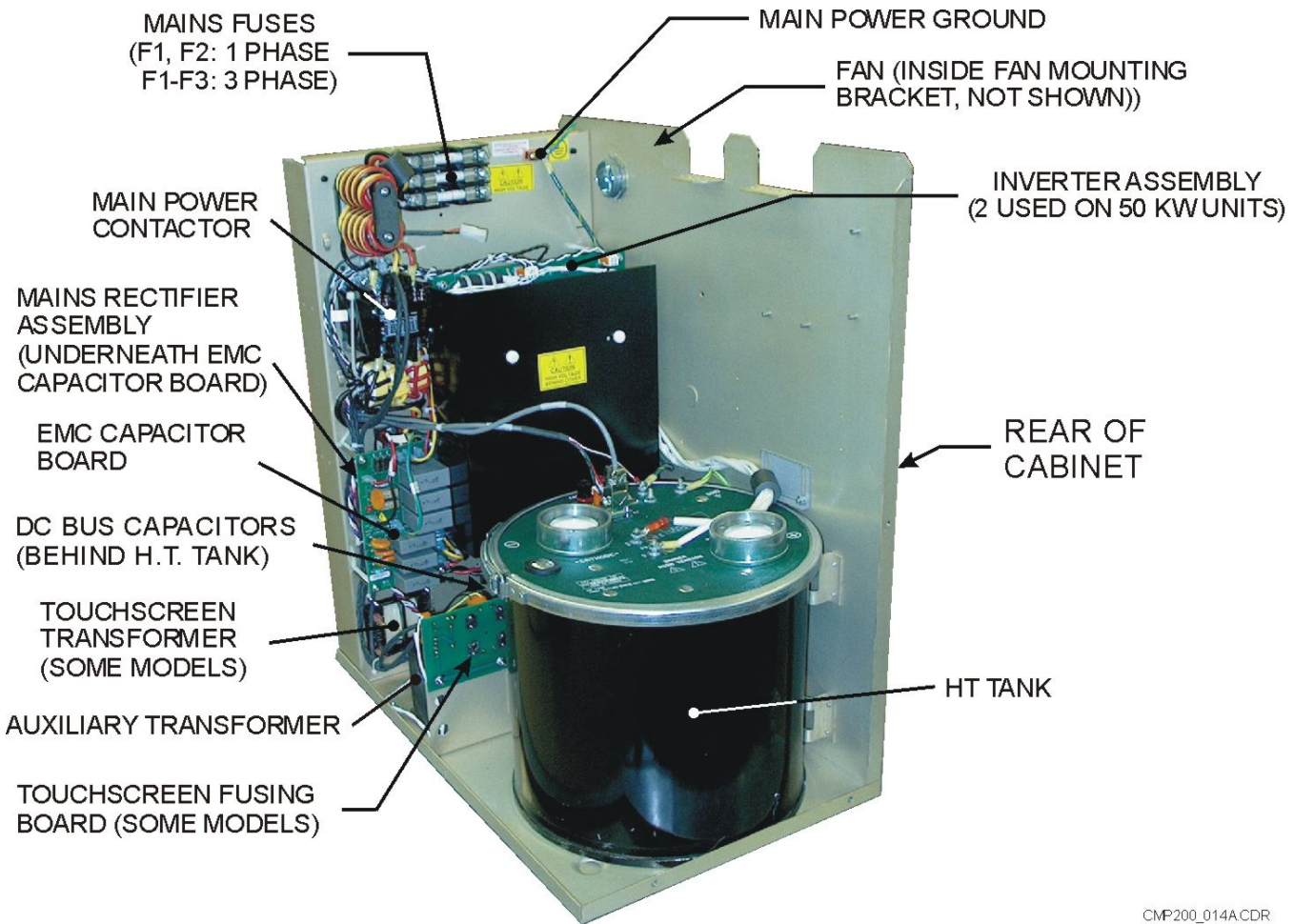

Figure 1-3: Major generator subassemblies view 1

Use and disclosure is subject to the restrictions on the title page of this CPI document

1.4.0 GENERATOR LAYOUT AND MAJOR COMPONENTS (Cont)

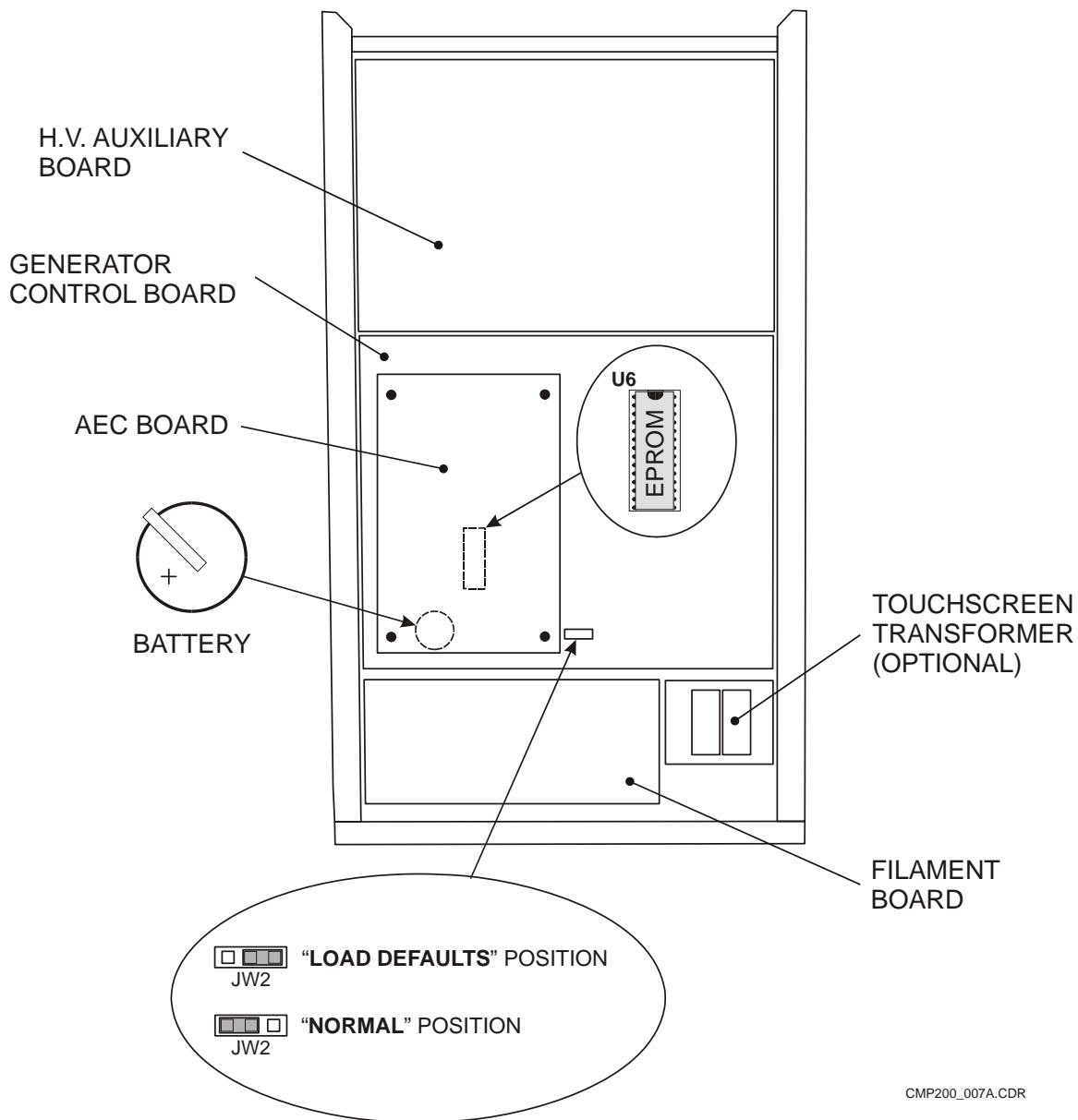

Figure 1-4: Major generator subassemblies view 2

Use and disclosure is subject to the restrictions on the title page of this CPI document.

1.4.0 GENERATOR LAYOUT AND MAJOR COMPONENTS (Cont)

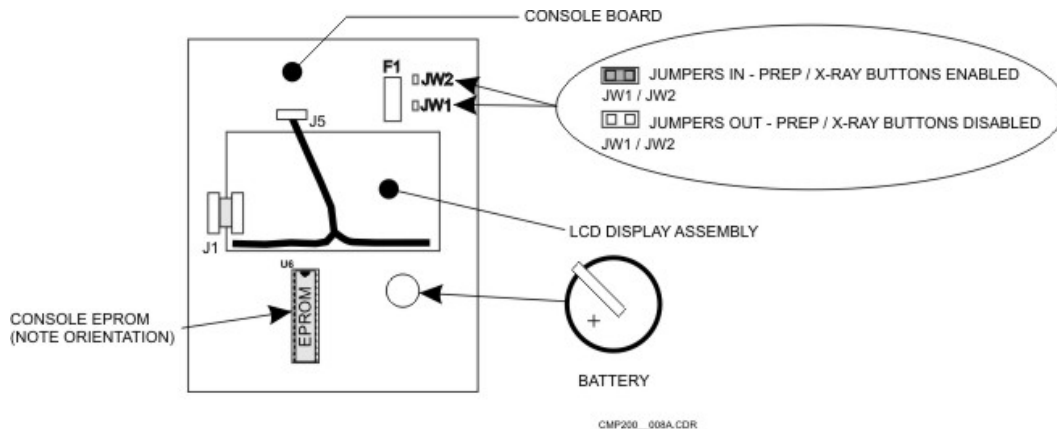

Figure 1-5: Console internal view including EPROM location

1.5.0 COMPATIBILITY LISTING

This X-ray generator is compatible with the following equipment:

X-RAY TUBES:

Refer to the compatibility statement and to chapter 2 of this manual.

NOTE: THE LOW SPEED STARTER IS COMPATIBLE WITH "R" TYPE STATORS OR GE 23/23 Ω EQUAL IMPEDANCE STATORS. REFER TO THE COMPATIBILITY STATEMENT OR THE SECTION "LOW SPEED STARTER TUBE COMPATIBILITY" IN CHAPTER 2 TO DETERMINE THE COMPATIBILITY OF YOUR GENERATOR.

AEC DEVICES:

Refer to the compatibility statement at the front of this manual.

1.6.0 CUSTOMER SUPPORT

Address any questions regarding X-ray generator operation to:

Mail: Customer Support Department
Communications and Power Industries Canada Inc.
45 River Drive
Georgetown, Ontario, Canada L7G 2J4

Telephone: (905) 877-0161

Fax: (905) 877-8320
Attention: Customer Support Department

E-mail: marketing@cmp.cpii.com
Attention: Customer Support Department

1.7.0 COMPATIBILITY STATEMENT

The compatibility statement for this generator is located at the front of this manual.

Use and disclosure is subject to the restrictions on the title page of this CPI document.

(This page intentionally left blank)

Use and disclosure is subject to the restrictions on the title page of this CPI document